

# V120-22-T2C

## Graphic Operator Panel & Programmable Logic Controller

12/24VDC, 12 pnp/npn digital inputs, 2 analog inputs, 3 high-speed counter/shaft encoder inputs, 12 transistor outputs, I/O expansion port, RS232/RS485 plus CANbus

Distributed by:  
M.A. Selmon Company, Inc  
4 Oxford Rd.  
Milford, CT 06460

203-377-3525

1

<b>Power supply</b>	12VDC or 24VDC
Permissible range	10.2VDC to 28.8VDC with less than 10% ripple
Maximum current consumption	130mA@24VDC (pnp inputs) 230mA@24VDC (npn inputs) 250mA@12VDC (pnp inputs) 290mA@12VDC (npn inputs)
<b>Digital inputs</b>	12 pnp (source) or npn (sink) inputs. See Notes 1 and 2.
Nominal input voltage	12VDC or 24VDC. See Notes 3 and 4.
Input voltages for pnp (source): For 12VDC	0-3VDC for Logic '0' 8-15.6VDC for Logic '1'
For 24VDC	0-5VDC for Logic '0' 17-28.4VDC for Logic '1'
Input voltages for npn (sink): For 12VDC	8-15.6VDC/<1.2mA for Logic '0' 0-3VDC/>3mA for Logic '1'
For 24VDC	17-28.4VDC/<2mA for Logic '0' 0-5VDC/>6mA for Logic '1'
Input current	4mA@12VDC 8mA@24VDC
Input impedance	3KΩ
Response time (except high-speed inputs)	10mS typical
Galvanic isolation	None
Input cable length	Up to 100 meters, unshielded
<b>High-speed counter</b>	Specifications below apply when inputs are wired for use as a high-speed counter input/shaft encoder. See Notes 5 and 6.
Resolution	32-bit
Input freq.	10kHz max.
Minimum pulse	40μs

### Notes:

- All 12 inputs can be set to pnp (source) or npn (sink) via a single jumper and appropriate wiring.
- Inputs #10 and #11 can function as either digital inputs or as analog inputs, via a single jumper and appropriate wiring.
- All 12 inputs can function in 12 VDC or 24 VDC; set via a single jumper and appropriate wiring.
- npn (sink) inputs use voltage supplied from the controller's power supply.
- Inputs #0, #2 and #4 can each function as either high-speed counter or as part of a shaft encoder. In each case, high-speed input specifications apply. When used as a normal digital input, normal input specifications apply.
- Inputs #1, #3 and #5 can each function as either counter reset, or as a normal digital input; in either case, specifications are those of a normal digital input. These inputs may also be used as part of a shaft encoder. In this case, high-speed input specifications apply.

### Shaft encoder

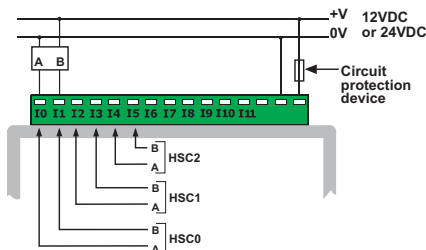

### Power supply, pnp (source) inputs

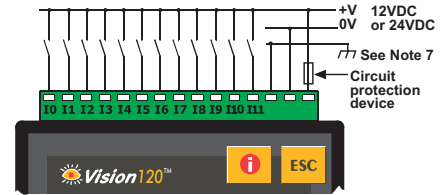

### Note 7:

To avoid electromagnetic interference, mount the controller in a metal panel/cabinet and earth the power supply. Earth the power supply signal to the metal using a wire whose length does not exceed 10cm. If your conditions do not permit this, do not earth the power supply.

### npn (sink) inputs

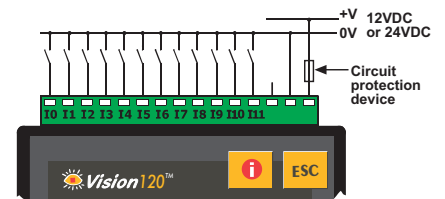

### pnp (source) high-speed counter

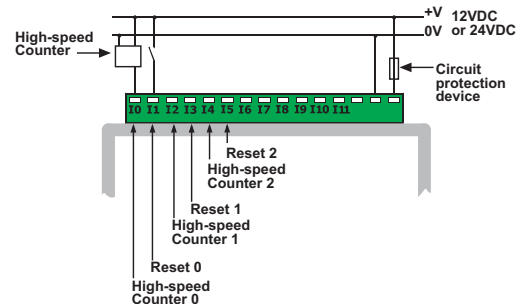

### npn (sink) high-speed counter

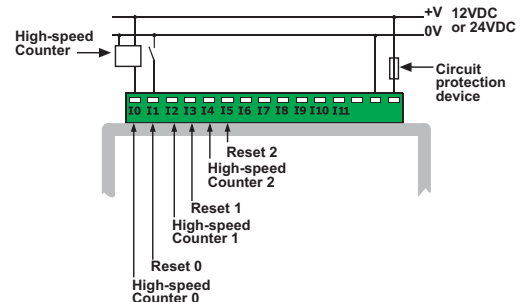

### Warnings:

- Unused pins should not be connected. Ignoring this directive may damage the controller.
- Improper use of this product may severely damage the controller.
- Refer to the controller's User Guide regarding wiring considerations.
- Before using this product, it is the responsibility of the user to read the product's User Guide and all accompanying documentation.

<b>Analog Inputs</b>	Two 10-bit, multi-range inputs: 0-10V, 0-20mA, 4-20mA See Note 2.
Conversion method	Successive approximation
Input impedance	>1M $\Omega$ for voltage 243 $\Omega$ for current
Galvanic isolation	None
Resolution (except 4-20mA)	10-bit (1024 units)
Resolution at 4-20mA	204 to 1023 (820 units)
Conversion time	Synchronized to scan time
Absolute max. rating	$\pm 15V$
Full scale error	$\pm 2$ LSB
Linearity error	$\pm 2$ LSB
Status indication	Yes, see Note 8

Note 8:

The analog value can also indicate when the input is functioning out of range. If an analog input deviates above the permissible range, its value will be 1024.

### Voltage / Current connection

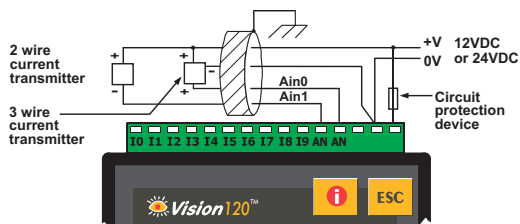
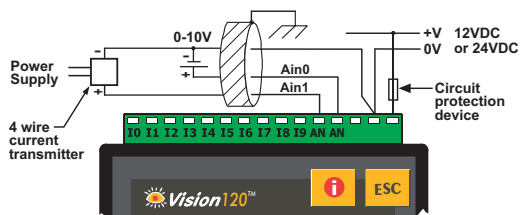

Note 9:

Voltage current connection shields should be connected at the signals' source. The 0V signal of the analog input must be connected to the controller's 0V.

<b>Digital outputs</b>	12 pnp (source) outputs 12VDC or 24VDC
Output type	P-MOSFET (open drain)
Isolation	None
Output current	0.5A max. Total current: 3A max.
Max. frequency for normal outputs	50Hz (resistive load) 0.5Hz (inductive load)
High speed output maximum frequency	2kHz (resistive load) See Note 10.
Short circuit protection	Yes
Short indication	by software
On voltage drop	0.5VDC maximum
<b>Power supply for outputs</b>	
Operating voltage	10.2 to 28.8VDC
Nominal operating voltage	12VDC or 24VDC

Note 10:

Output #0 and Output #1 may be used as high-speed outputs.

### Outputs connection

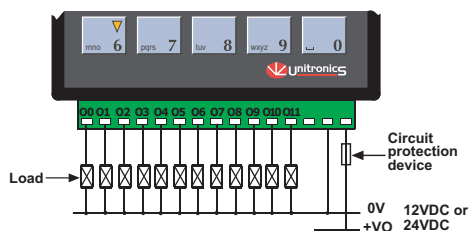

<b>Graphic Display</b>	STN, LCD display
Illumination backlight	LED, yellow-green, software-controlled
Display resolution	128x64 pixels
<b>Keypad</b>	Sealed membrane
Number of keys	16
<b>Program</b>	
Application Memory	448K
Memory Bits (coils)	2048
Memory Integers (registers)	1600
Long Integers (32 bit)	256
Double Word (32 bit unsigned)	64
Floats	24
Timers	192
Counters	24
Data Tables	120K (RAM) / 64K (FLASH)
HMI displays	Up to 255
Execution time	0.8 $\mu$ s for bit operations

### RS232/RS485 serial port

Used for:

- Application Download/Upload
- Application Testing (Debug)
- Connect to GSM or standard telephone modem:
  - Send/receive SMS messages
  - Remote access programming
- RS485 Networking

<b>RS232</b> (See Note 11)	2 ports
Galvanic isolation	None
Voltage limits	$\pm 20V$
<b>RS485</b> (See Note 11)	1 port
Input voltage	-7 to +12V differential max.
Cable type	Shielded twisted pair, in compliance with EIA RS485
Galvanic isolation	None
Baud rate	110 – 57600 bps
Nodes	Up to 32

Note11:

RS232/RS485 is determined by jumper settings and wiring. Refer to the controller's User Guide regarding communications.

### I/O expansion port

Up to 128 additional I/Os, including digital & analog I/Os, RTD and more.

### CANbus port

Up to 63 nodes	
Baud rate range	20Kbps - 1Mbps
Cable length	Up to 150m for 12VDC network Up to 1000m for 24VDC network

### CANbus connection

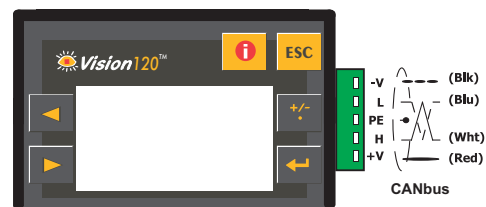

### Miscellaneous

Clock (RTC)	Real-time clock functions. (Date and Time)
Battery back-up	7 years typical battery back-up for RTC and system data.
Weight	240g (8.46 oz.)
Operational temperature	0 to 50°C (32 to 122°F)
Storage temperature	-20 to 60°C (-4 to 140°F)
Relative Humidity (RH)	5% to 95% (non-condensing)
Mounting method	DIN-rail mounted (IP20/NEMA1) Panel mounted (IP65/NEMA4X)

# V120-22-T2C

## I/O Jumper Settings

The tables below show how to set a specific jumper to change the functionality of the controller. To open the controller and access the jumpers, refer to the directions at the end of these specifications.

### Important:

Incompatible jumper settings and wiring connections may severely damage the controller.

#### JP1 Digital Inputs type

To use as	JP1
npn (sink)	A
pnp (source)*	B

#### JP2 Inputs voltage

To use as	JP2
12VDC	A
24VDC*	B

\*Default factory setting

#### JP3, JP4 Analog inputs type

To use as	JP3 for analog input #1	JP4 for analog input #0
Voltage input*	A	A
Current input	B	B

#### JP5, JP6 Digital/Analog inputs

Range	JP5 for AN1 / In#10	JP6 for AN0 / In#11
Digital inputs*	A	A
Analog inputs	B	B

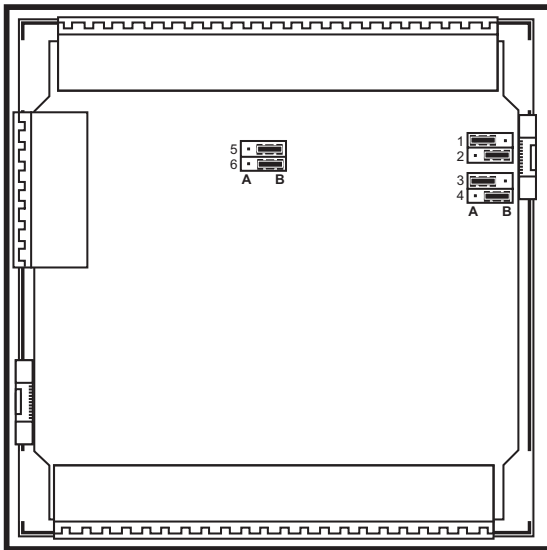

In this figure, the jumper settings will cause the controller to function as follows:

- Digital inputs: npn, 24VDC inputs
- Analog input #0: Voltage input
- Analog input #1: Current input

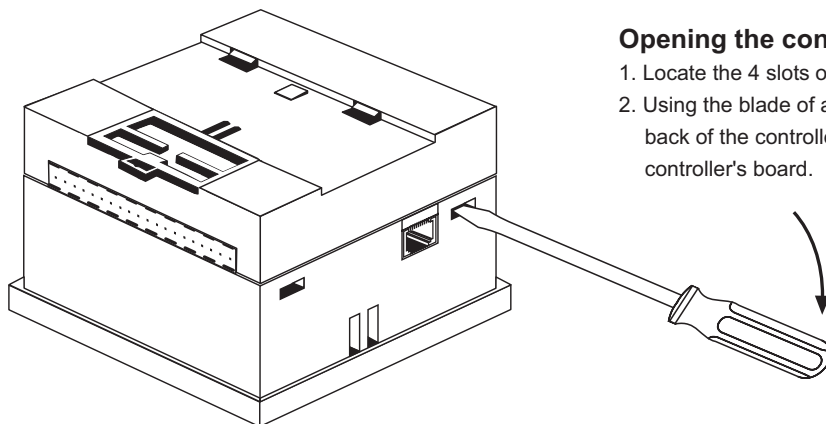

#### Opening the controller enclosure

1. Locate the 4 slots on the sides of the enclosure
2. Using the blade of a flat-bladed screwdriver, gently pry off the back of the controller as shown in the figure below, exposing the controller's board.

Unitronics reserves the right to revise this publication from time to time and to amend its contents and related hardware and software at any time. Technical updates (if any) may be included in subsequent editions (if any).

Unitronics product sold hereunder can be used with certain products of other manufacturers at the user's sole responsibility.