



Series 626 & 628 Pressure Transmitters

Specifications - Installation and Operating Instructions



-CH Conduit Housing



-GH General Purpose Housing

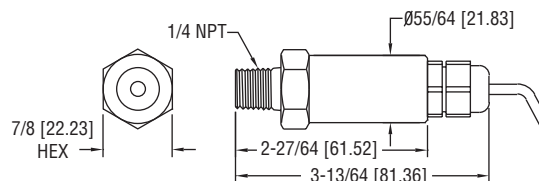
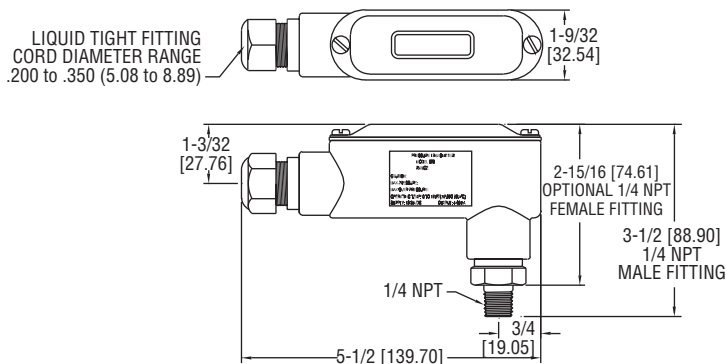

The Series 626 and 628 Pressure Transmitters converts a single positive pressure into a standard 4-20 mA output signal. The Series 626 and 628 can be used to accurately measure compatible gases and liquids; Series 626 full scale accuracy is 0.25%; Series 628 full scale accuracy is 1.0% (see specifications). Designed for industrial environments with a NEMA 4X (IP66) housing, this transmitter resists most effects of shock and vibration.



CAUTION: Do not exceed specified supply voltage ratings. Permanent damage not covered by warranty will result. This device is not designed for 120 or 240 volt AC operation. Use only on 13 to 30 VDC.

Pressure Ranges		
Pressure Range	Maximum Pressure	Over Pressure
0-15 psia	30 psia	45 psia
15-0 psia	30 psia	45 psia
0-30 psia	60 psia	90 psia
0-50 psia	100 psia	150 psia
0-100 psia	200 psia	300 psia
0-200 psia	400 psia	600 psia
0-300 psia	600 psia	900 psia
0-5 psig	10 psig	50 psig
0-15 psig	30 psig	150 psig
0-30 psig	60 psig	300 psig
0-50 psig	100 psig	300 psig
0-100 psig	200 psig	500 psig
0-150 psig	300 psig	750 psig
0-200 psig	400 psig	1000 psig
0-300 psig	600 psig	1500 psig
0-500 psig	1000 psig	2500 psig
0-1000 psig	2000 psig	5000 psig
0-1500 psig	3000 psig	5000 psig
0-2000 psig	4000 psig	5000 psig
0-3000 psig	6000 psig	7500 psig
0-5000 psig	7500 psig	10000 psig
0-8000 psig	10000 psig	12000 psig

SPECIFICATIONS

Service: Compatible gases and liquids.
Wetted Materials: Type 316 SS.
Accuracy: 626: 0.25% FS, 0.20% RSS; 628: 1.0% FS, 0.5% RSS; 626 absolute ranges: 0.5% FS, 0.35% RSS. (Includes linearity, hysteresis, and repeatability).
Temperature Limit: 0 to 200°F (-18 to 93°C).
Compensation Temperature Range: 0 to 175° (-18 to 79°C).
Thermal Effect: 626: ±0.02% FS/°F. 628: ±0.04% FS/°F (includes zero and span).
Pressure Limits: See table.
Power Requirements: 10-30 VDC (for 4-20 mA, 0-5, 1-5, 1-6 VDC outputs); 13-30 VDC (for 0-10, 2-10 VDC outputs); 5 VDC ±0.5 VDC (for 0.5-4.5 VDC ratio-metric output).
Output Signal: 4-20 mA, 0-5 VDC, 1-5 VDC, 0-10 VDC, or 0.5-4.5 VDC.

Response Time: 300 ms.

Loop Resistance: 0-1000 Ohms max. R max = 50 (Vps-10) Ohms (4-20 mA output), 5K Ohms (0-5, 1-5, 1-6, 0-10, 2-10, 0.5-4.5 VDC output).
Current Consumption: 38 mA maximum (for 4-20 mA output); 10 mA maximum (for 0-5, 1-5, 1-6, 0-10, 2-10, 0.5-4.5 VDC output); 140 mA maximum (for all 626/628/629-CH with optional LED).
Electrical Connections: Conduit Housing (-CH): terminal block, 1/2" female NPT conduit; General Purpose Housing (-GH): cable DIN EN 175801-803-C.
Process Connection: 1/4" male or female NPT and BSPT.
Enclosure Rating: NEMA 4X (IP66).
Mounting Orientation: Mount in any position.
Weight: 10 oz (283 g).
Agency Approvals: CE.

INSTALLATION

- 1. Location:** Select a location where the temperature of the transmitter will be between 0 and 175°F (-18 to 79°C). Distance from the receiver is limited only by total loop resistance. The tubing or piping supplying pressure to the unit can be practically any length required but long lengths will increase response time slightly.
- 2. Position:** The transmitter is not position sensitive. However all standard models are originally calibrated with the unit in a position with the pressure connection downward. Although they can be used at other angles, for best accuracy it is recommended that units be installed in the position calibrated at the factory.
- 3. Pressure Connection:** Use a small amount of plumber's tape or other suitable sealants to prevent leaks. Be sure the pressure passage inside the port is not blocked.

4. Electrical Connections

Wire Length -The maximum length of wire connecting the transmitter and receiver is a function of wire size and receiver resistance. Wiring should not contribute more than 10% of the receiver resistance to total loop resistance. For extremely long runs (over 1000 feet), choose receivers with higher resistance to minimize the size and cost of connecting leads. Where wiring length is under 100 feet, wire as small as 22 AWG can be used.

M.A. Selmon Company, Inc
 4 Oxford Rd.
 Milford, CT 06460
 203-377-3525

CURRENT (4-20 mA) OUTPUT OPERATION

An external power supply delivering 10-30 VDC with minimum current capability of 40 mA DC (per transmitter) is required to power the control loop. See Fig. A for connection of the power supply, transmitter and receiver. The range of appropriate receiver load resistance (R_L) for the DC power supply voltage available is expressed by the formula:

$$R_L \text{ Max} = \frac{V_{ps} - 10}{20 \text{ mA DC}}$$

Shielded cable is recommended for control loop wiring.

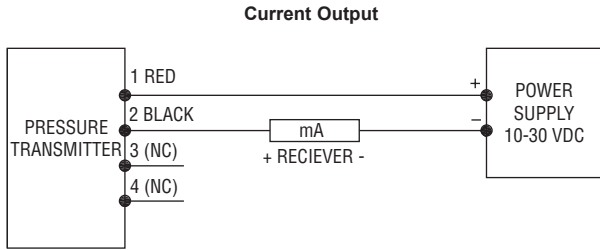

Fig. A: Current output connection

Conduit Housing with 4-20 mA Output (-CH) Electrical connections to the pressure transmitters are made to the terminal block located inside the housing. Remove the screws and lift off the cover. Wire as shown in Fig. A, B or C. Use Fig. A for current output connection. Use Fig. B for current output with optional LED display. Use Fig. C for current output with optional LED display using two power supplies.

If ordering optional pre-wired cable, black wire is negative (-) and red wire is positive (+).

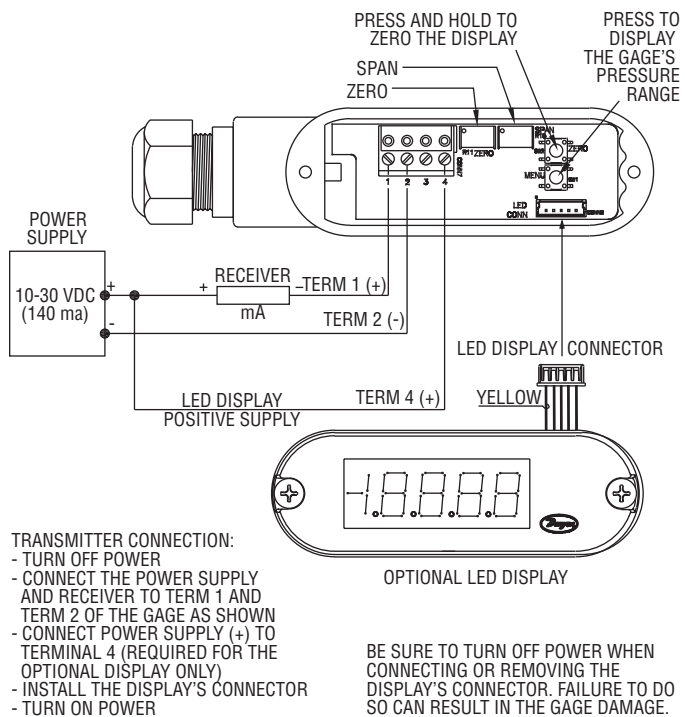
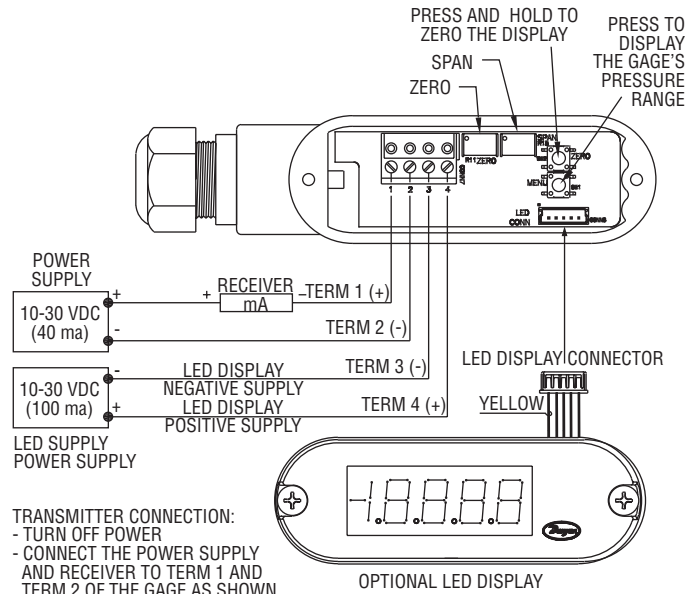

Fig. B: Current output with optional LED display connection

- TRANSMITTER CONNECTION:**
- TURN OFF POWER
 - CONNECT THE POWER SUPPLY AND RECEIVER TO TERM 1 AND TERM 2 OF THE GAGE AS SHOWN
 - CONNECT POWER SUPPLY (+) TO TERMINAL 4 (REQUIRED FOR THE OPTIONAL DISPLAY ONLY)
 - INSTALL THE DISPLAY'S CONNECTOR
 - TURN ON POWER

BE SURE TO TURN OFF POWER WHEN CONNECTING OR REMOVING THE DISPLAY'S CONNECTOR. FAILURE TO DO SO CAN RESULT IN THE GAGE DAMAGE.



- TRANSMITTER CONNECTION:**
- TURN OFF POWER
 - CONNECT THE POWER SUPPLY AND RECEIVER TO TERM 1 AND TERM 2 OF THE GAGE AS SHOWN
 - CONNECT LED POWER SUPPLY (-) TO TERMINAL 3
 - CONNECT LED POWER SUPPLY (+) TO TERMINAL 4
 - INSTALL THE DISPLAY'S CONNECTOR
 - TURN ON POWER

BE SURE TO TURN OFF POWER WHEN CONNECTING OR REMOVING THE DISPLAY'S CONNECTOR. FAILURE TO DO SO CAN RESULT IN THE GAGE DAMAGE.

Fig. C: Current output with optional LED display using two power supplies

Hirschman DIN Connector with 4-20 mA When using cable version of -GH General Purpose Housing, black wire is negative (-) and red wire is positive (+). When using optional Hirschman DIN Plug, remove top-center screw and lift off the terminal block assembly. Wire to terminals shown below in Fig. D. For optional 4-pin M-12 connector, wire to pins as shown in Fig. E.

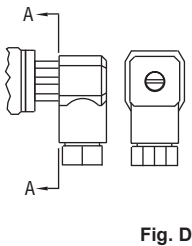

Fig. D

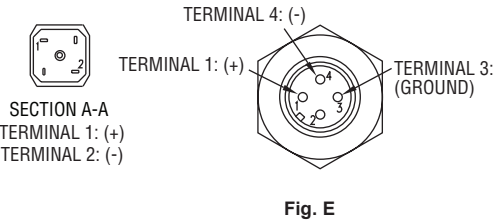

Fig. E

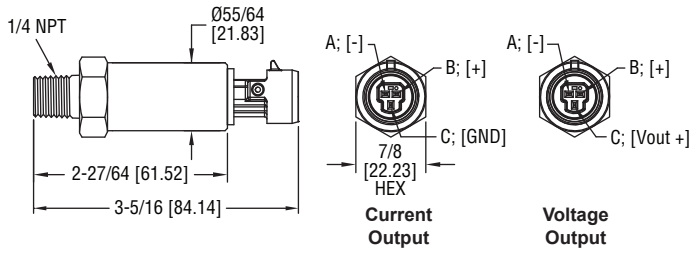

Fig. F: Packard Connection

VOLTAGE (0-5, 1-5, 0-10, 1-6 or 2-10 VDC) OUTPUT OPERATION

(Other outputs contact the factory) See Fig. G for connection of the power supply, transmitter and receiver.

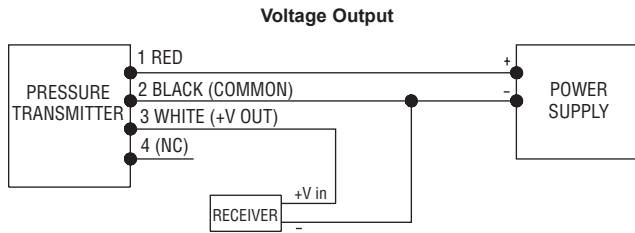
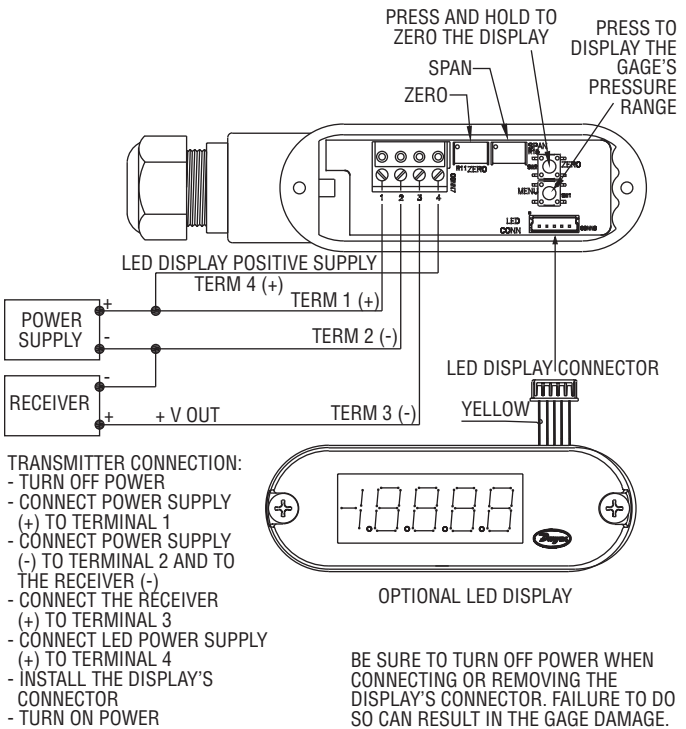

Fig. G: Voltage output connection

Conduit Housing (-CH) Electrical connections to the pressure transmitters are made to the terminal block located inside the housing. Remove the screws and lift off the cover. Wire as shown in Fig. G or Fig. H. Use Fig. G for voltage output connection. Use Fig. H for voltage output with optional LED display connection. If ordering optional pre-wired cable, black wire is negative (-), red wire is positive (+) and white wire is +Vout.



- TRANSMITTER CONNECTION:**
- TURN OFF POWER
 - CONNECT POWER SUPPLY (+) TO TERMINAL 1
 - CONNECT POWER SUPPLY (-) TO TERMINAL 2 AND TO THE RECEIVER (-)
 - CONNECT THE RECEIVER (+) TO TERMINAL 3
 - CONNECT LED POWER SUPPLY (+) TO TERMINAL 4
 - INSTALL THE DISPLAY'S CONNECTOR
 - TURN ON POWER

BE SURE TO TURN OFF POWER WHEN CONNECTING OR REMOVING THE DISPLAY'S CONNECTOR. FAILURE TO DO SO CAN RESULT IN THE GAGE DAMAGE.

Fig. H: Voltage output with optional LED display connection

Hirschman DIN Connector with Voltage Output When using cable version of -GH General Purpose Housing, black wire is negative (-), red wire is positive (+) and white wire is output. When using optional Hirschman DIN Plug, remove top-center screw and lift off the terminal block assembly. Wire to terminals shown below in Fig. I. For optional 4-pin M-12 connector, wire to pins as shown in Fig. J. If utilizing optional A-164 cable for M-12 connection, brown wire corresponds to pin #1, white #2, blue #3, and black #4.

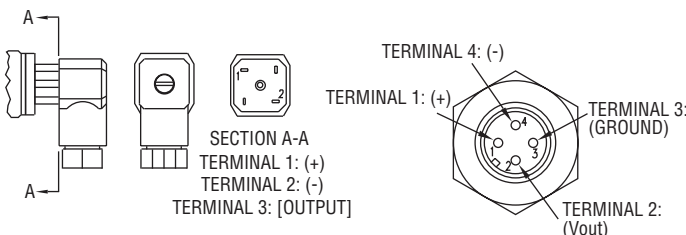

Fig. I

Fig. J

RATIOMETRIC (0.5-4.5 VDC) OUTPUT OPERATION

(Other outputs contact the factory) See Fig. K for connection of the power supply, transmitter and receiver.

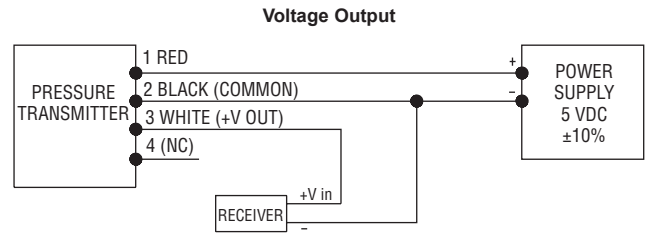

Fig. K: Voltage output connection

General Purpose Housing with Ratiometric Output When using cable version of -GH General Purpose Housing, black wire is negative (-), red wire is positive (+) and white wire is output. When using optional Hirschman DIN Plug, remove top-center screw and lift off the terminal block assembly. Wire to terminals shown below in Fig. L. For optional 4-pin M-12 connector, wire to pins as shown in Fig. M. If utilizing optional A-164 cable for M-12 connection, brown wire corresponds to pin #1, white #2, blue #3, and black #4.

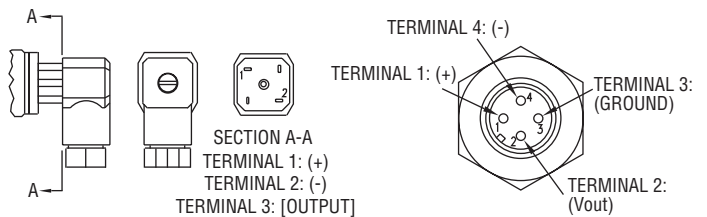

Fig. L

Fig. M

MAINTENANCE

After final installation of the pressure transmitter and its companion receiver, no routine maintenance is required. A periodic check of system calibration is suggested. The Series 626 and 628 transmitters are not field repairable and should be returned if repair is needed (field repair should not be attempted and may void warranty). Be sure to include a brief description of the problem plus any relevant application notes. Contact customer service to receive a return goods authorization number before shipping.

